

wedi Fundo Primo



Overview & General Product Description of the wedi Bathroom System

All wedi Waterproof Shower Systems including point and linear drain models offer reliable, cost-efficient solutions for constructing 100% waterproof and mould proof showers. The product systems are entirely waterproof due to its XPS extruded polystyrene foam core. These systems are easy and clean to install due to its high prefabrication level. They open up a whole new world of design possibilities for showers, wet areas and baths when customized to fit your jobsite requirements.

wedi Bathroom Systems blend the traditional values of design flexibility and robustness as previously only enjoyed with screed installations, while offering added values that come with state-of-the-art material and manufacturing technologies. These added values come in form of many performance advantages. Especially over traditional screed installations or over other currently known methods for building showers such as those using sheet – or liquid waterproofing membranes in an attempt to manage water exposure. The most unique advantage is the complete and natural core waterproofness of the wedi product and its entire assembly. Every detail of the assembly is part of the wedi waterproofing approach: even down to the factory integrated drain parts. The concept of the wedi Fundo Shower System's water management describes a true "water out" performance. Neither products nor the assembly of the wedi Fundo shower system is subjected to the risks so commonly found in other methods of shower installation. When installing wedi Fundo Shower Systems in combination with wedi building boards, the proprietary wedi 610 adhesive sealant and any of our hobs, niches or seats accessories, you can eliminate the following worries altogether:

- No overlapping sheet waterproofing seams with just tile adhesive in between
- No risk of forming pinholes as with installation of very thin liquid membranes
- No weepholes and clogging as with liner installations
- No liner cracks due to aging or exposure to elements
- No mould or discoloration worries as with absorbing and permanently wet screed beds

These added values and its detail perfections eliminate the technical concerns in shower installations. But this is not where wedi shower systems stop offering its added values: The wedi Fundo shower system adds to your productivity and enables you to provide real value to your customers: Our wedi Fundo Shower systems reduce the installation time for just the shower floor from a 2 – 3 day process (includes drying times) to only 30 minutes when compared to traditional methods built with screed and liquid applied membranes. wedi helps you to turn showers into service quicker, cleaner, safer. The exact and consistently shaped slope fields support perfection in tile setting and design. The cement based resin surface coatings on our products provide a great bond surface for any tile, stone and many other materials. Using any cement based tile adhesive adhesives in installation. The insulation properties of the extruded foam core of our wedi systems keep the tile warmer on the floor and add to better insulation of the wall. And all this under one warranty for the entire shower from floor to wall.

wedi Fundo Ligno is designed to provide for a low profile base thickness of only 20 mm. This allows for a fast and flush installation into a subfloor assembly without cutting into floor joists. The system is designed to work without a hob. Enjoy the ease of installation without creating a structural hazard because you maintain the structural subfloor panels installed between floor joists under the wedi Fundo Ligno. Because barrier free showers may be exposed to heavy point loads (e.g. wheel chair), you can confidently rely on the structural strength of the wedi base and subfloor as well as the wedi Fundo's traditional strong cement based surface for ideal tile bond using any suitable cement based tile adhesives or grouts. As always with wedi Fundo Shower Systems, wedi Fundo Ligno is designed to interlock and work with wedi building boards, wedi 610 adhesive sealant, wedi Fasteners, wedi Seats and Benches, wedi Niches and many more accessories, that truly complete your shower installation and waterproofing system. The installation is fast, modular but customizable, and covered by wedi's full system warranty.



Drain to Base Assembly

These added values and its detail perfections eliminate the technical concerns in shower installations. But this is not where wedi shower systems stop offering its added values: The wedi Fundo shower system adds to your productivity and enables you to provide real value to your customers: Our wedi Fundo Shower systems reduce the installation time for just the shower floor from a 2 day process (includes drying times) to only 30 minutes when compared to traditional methods built with screed and topically applied liquid membrane. wedi helps you to turn showers into service quicker, cleaner, safer. Especially for our contractors, Fundo Primo helps to get to setting tile faster and on a much more consistent and tile friendly surface. Customers will appreciate the 'no noise and no dirt and dust' installation. The wedi products do not contain harmful ingredients providing peace of mind to contractors and end users.

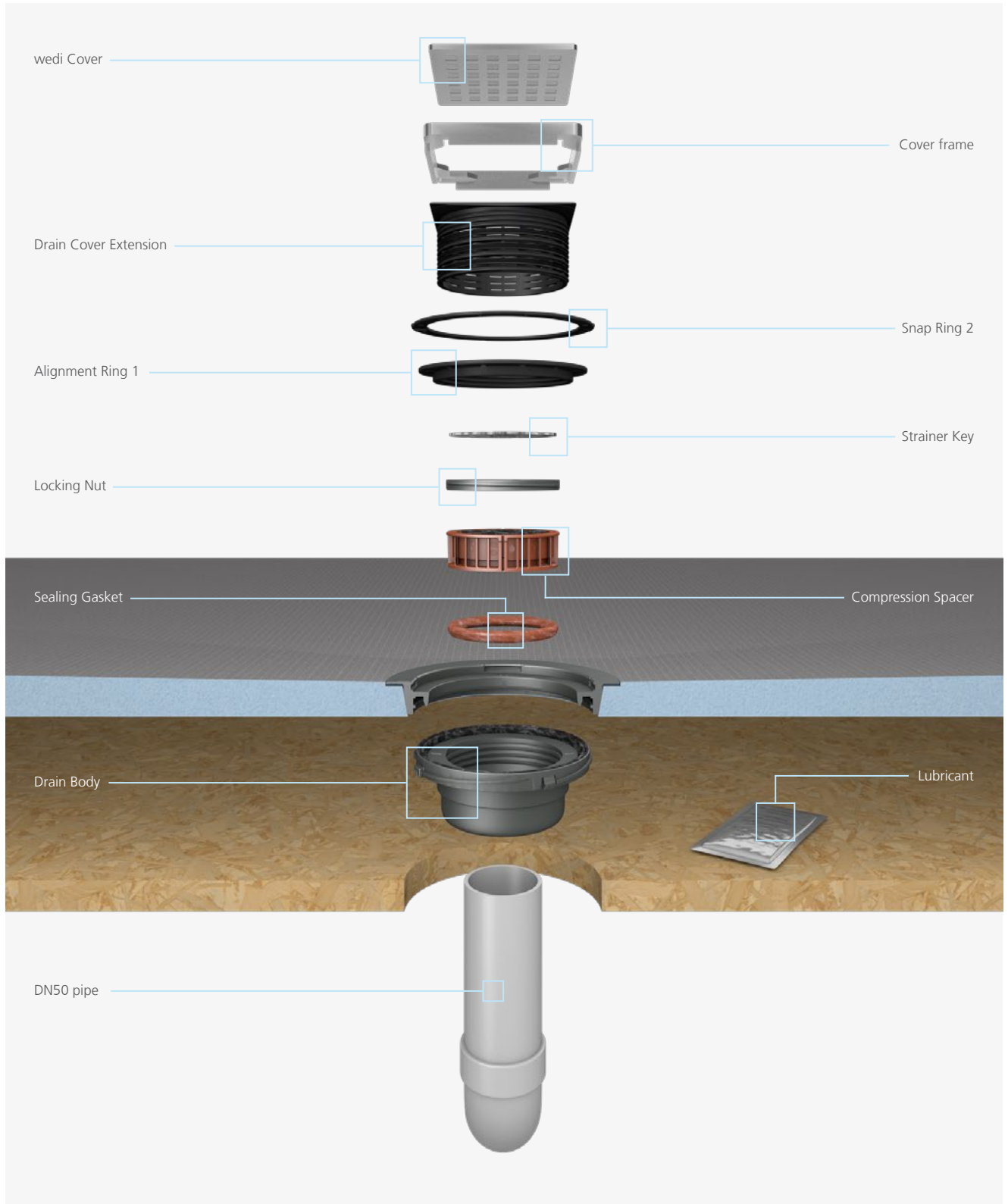

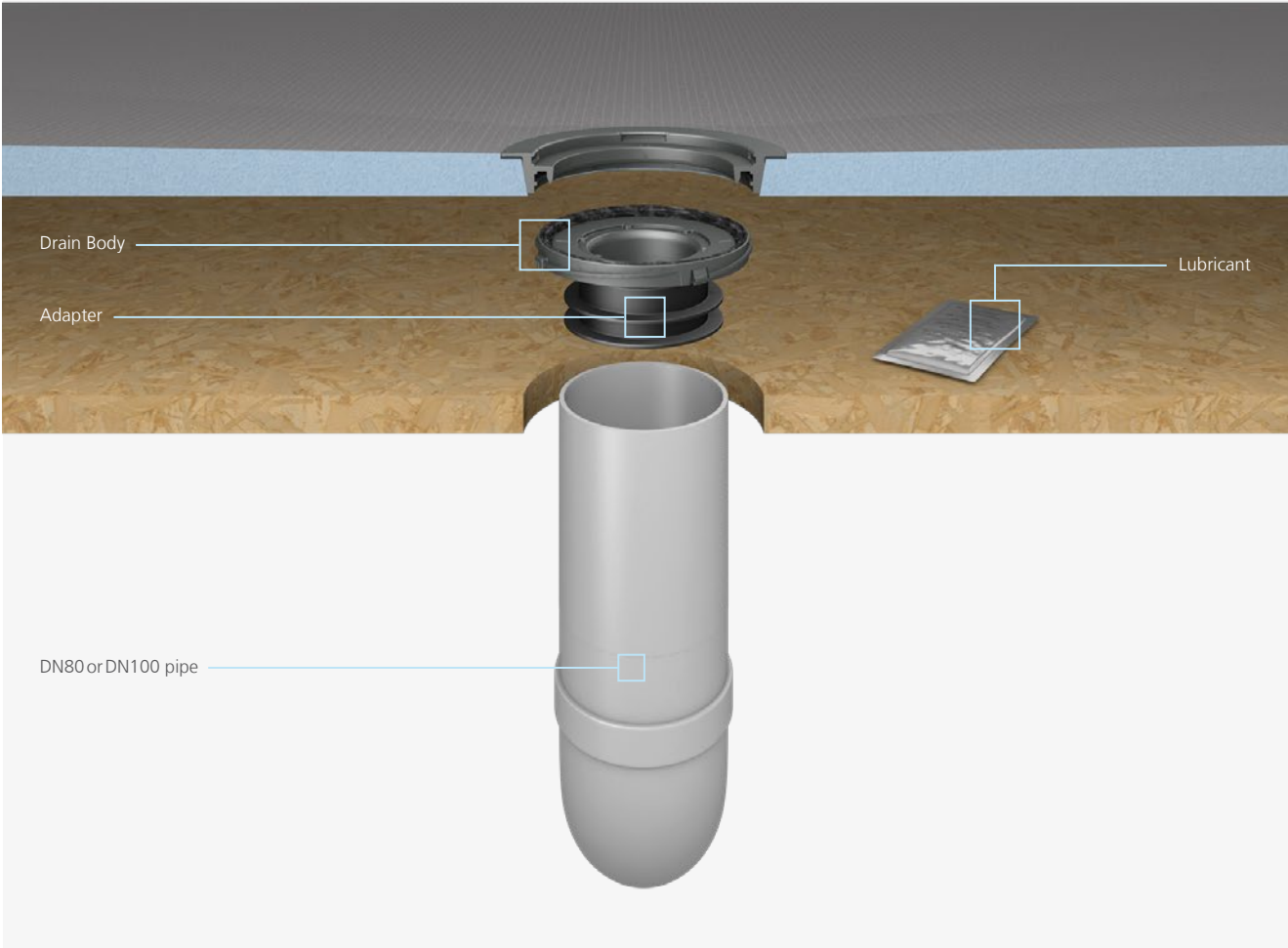
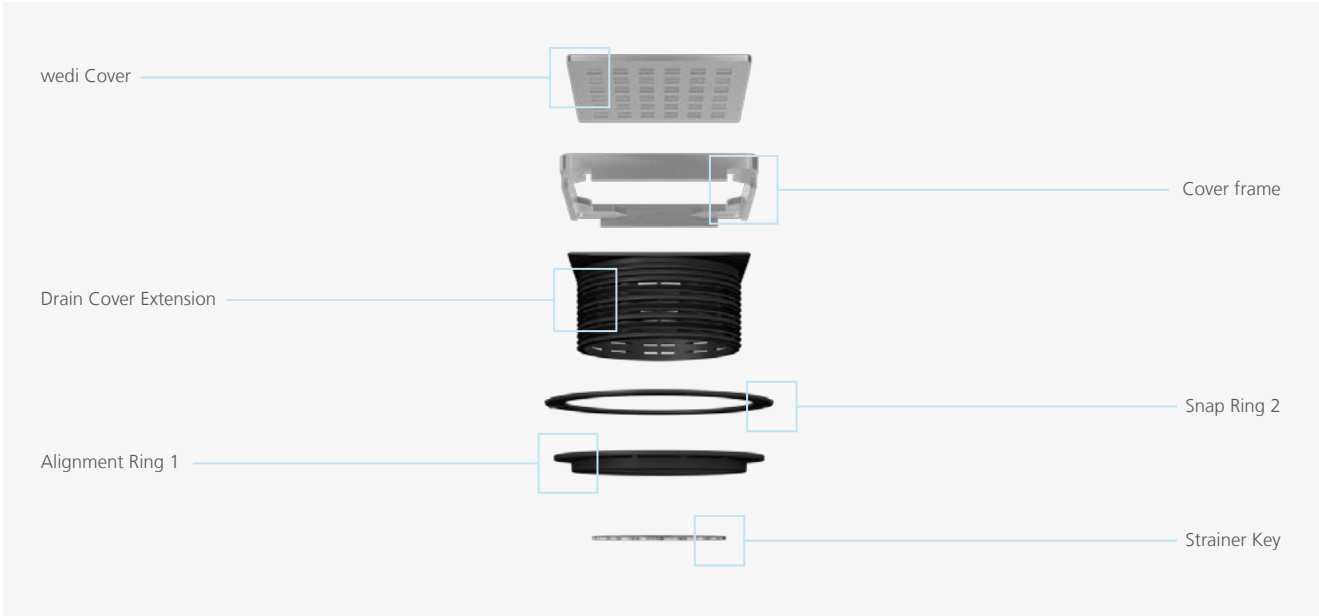



Cut the DN50 pipe even and flush with the subfloor surface. Make sure that the cut out fits to the Fundo base's drain. Cut out a 130 mm diameter hole around the DN50 pipe's center to allow for the wedi drain to be inserted into the subfloor while the cut out area must remain free of deflection. The drain waste pipe and P-trap have to be safely affixed to and supported by the sub-floor structure.



Next, install the Fundo Click and Seal drain unit. Drain components are delivered inserted inside the Drain Body. Please take the parts out and use step by step following our manual here.



Apply the wedi provided safe Lubricant to the black rubber ring inside the wedi Drain Body.



Insert the Drain Body snugly into the receiving mechanism of the Drain Unit on the underside of the Fundo base.

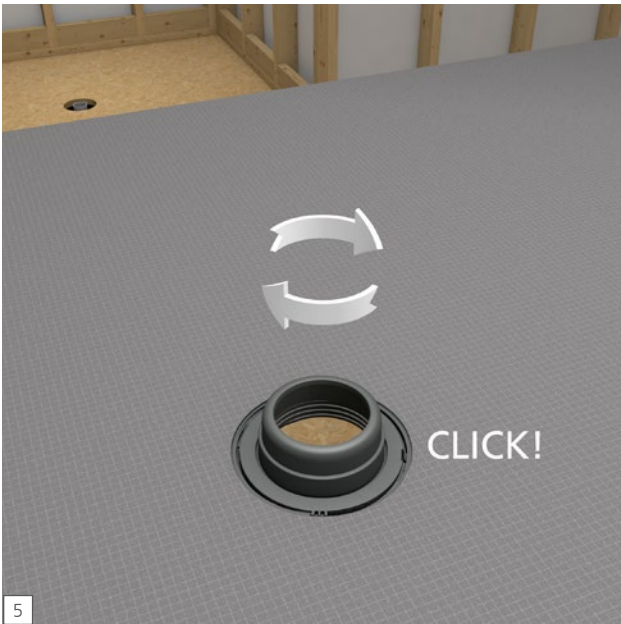

Once inserted, turn the Drain Body clockwise until it “clicks” into final position and you will see the imprinted arrow on drain unit aligning at the base’s click mechanism. This will require no more than a quarter turn. Ensure a tight connection by lightly pulling and pushing on the Drain Body. The Fundo base and its Drain Unit is now ready for installation. Should you want to remove the Drain Body at any time, this can be done by pushing the snap mechanism’s plastic flap inwards using a flat headed screwdriver and while unscrewing the Drain Body to the left at the same time.

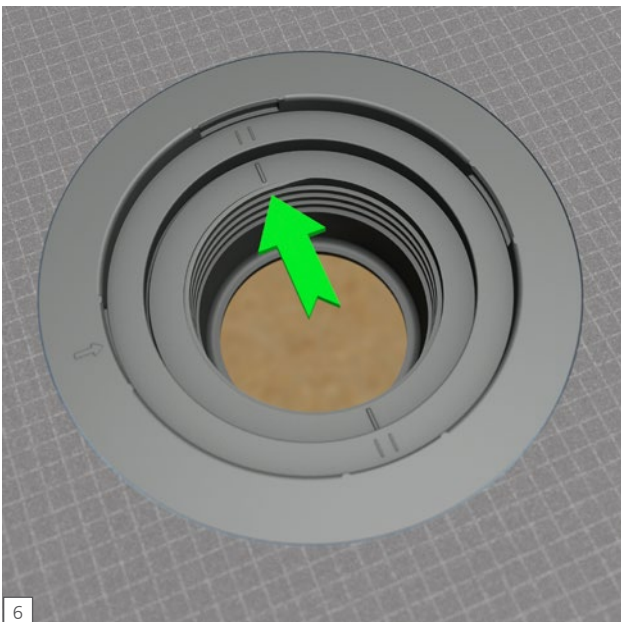

On the top side of the drain you can also verify the drain unit has successfully connected when the single hash marks are centered between the double hash marks.



Trowel the tile adhesive and comb through with a 10 × 10 mm notch trowel. Channels pointing to the entrance.



Trowel the tile adhesive on the rear side of the Fundo again using a 10 × 10 mm notch trowel. There are different ways to ensure good bond of the wedi base to the subfloor. Applying tile adhesive on both, wedi base and subfloor, is a best practice recommended to achieve full surface coverage adhesion.



Press the Fundo firmly into the tile adhesive bed, ensuring that the installation is level and void free. Apply some weight equally and leave on surface and drain area to allow the tile adhesive to initially cure without being disturbed (e.g. tile adhesive bags). Do NOT step on the drain module to push/connect to drain body or tile adhesive. Ensure there is 100 % tile adhesive supporting the drain channel area over a completely flat subfloor.

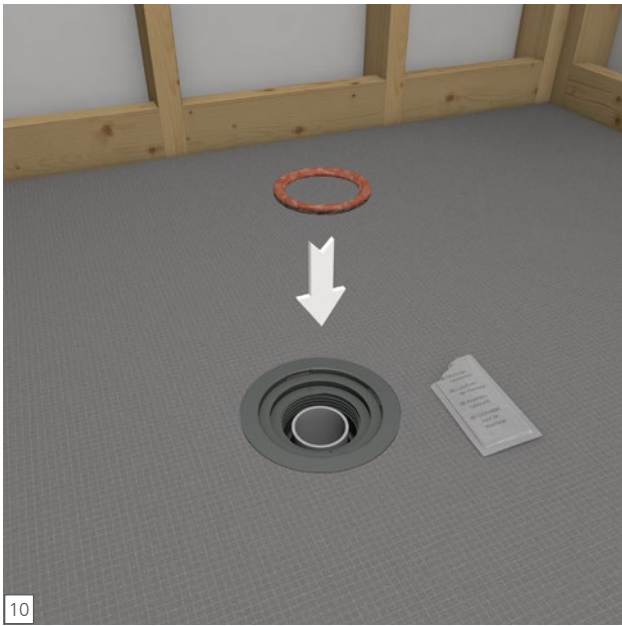

Apply wedi provided safe Lubricant to the Rubber Sealing Gasket and insert the Rubber Sealing Gasket between the wedi Drain Unit's interior and the outside of the DN50 waste pipe in the floor. Push the Rubber Sealing Gasket down along the waste pipe until it is stopped by the Drain Unit's lower interior flange.



Apply wedi provided safe Lubricant to the rubber part of the Compression Spacer. With the rubberized part pointing up now insert the Compression Spacer in between Drain Unit and waste pipe and on top of the Sealing Gasket. The Compression Spacer will push the Rubber Sealing Gasket down into its resting position.

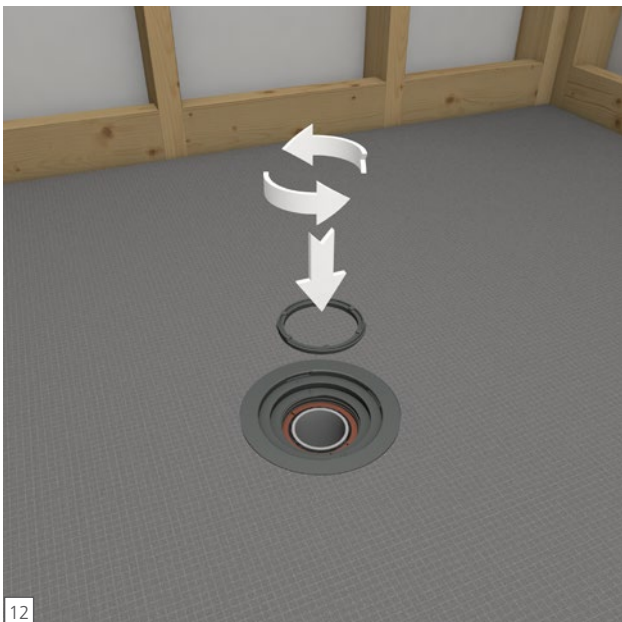

Insert the Locking Nut with notched side up into the threaded part of the Drain Unit opening and screw down until Locking Nut top is flush with top edge of Drain Unit's threaded part. **Important: Turn Locking Nut to LEFT to insert and screw into flush position (turn Counter-Clockwise).**

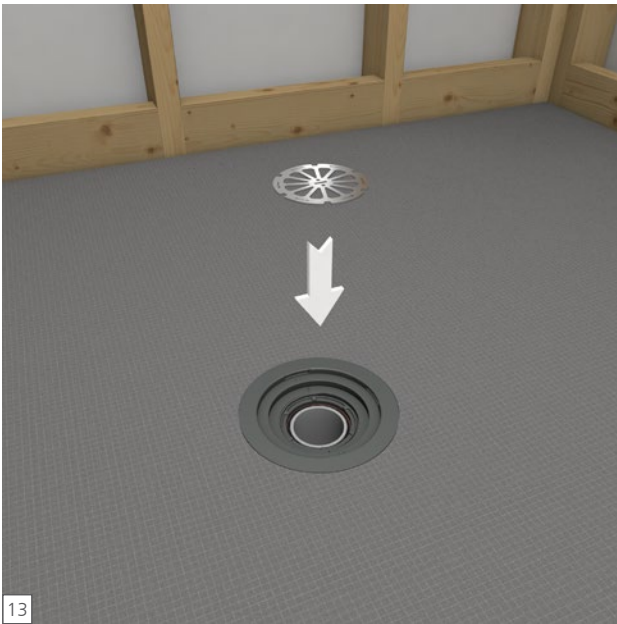

Insert Strainer Key into Locking Nut at notch connections and with Strainer Key printed side up. The Strainer Key is used as a tool to tighten the compression seal of the Drain Unit, but remains in place later to serve as a hair catcher to protect the drain and make maintenance and cleaning easy.



Insert a flat headed screwdriver into Strainer Key slit and turn **LEFT** to tighten the compression seal (turn Counter-Clockwise). Achieve a hand-tight fit and do not over-tighten.



Set up a continuous 10 mm bead of wedi 610 adhesive sealant along the pans channel on the outer perimeter and only in areas where you can immediately install a building board into the fresh sealant.



Push the wedi board all the way into the channel of the shower base channel and its bead of sealant. Smooth out any pushed out sealant on inside seam using a putty knife. Fasten the boards directly to the studs starting 300 mm above the base and at a rate of 1 fastener per 300 mm. One extra fastener is set into the seam to the next board to create a flush transition.

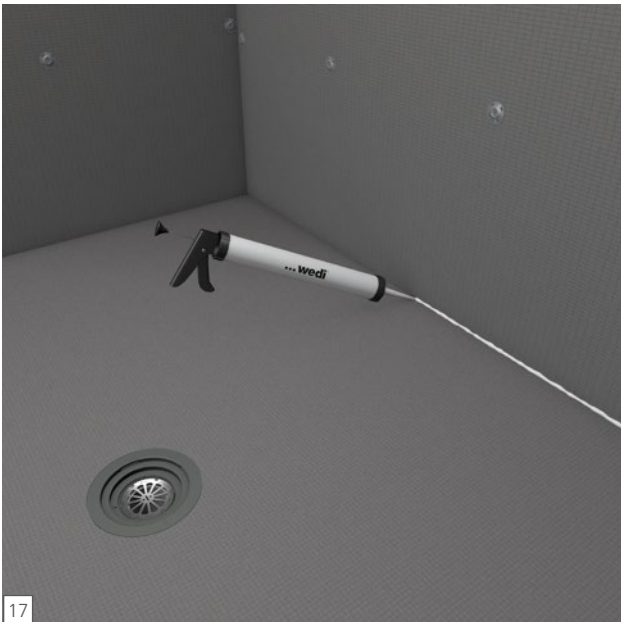

Apply continuous 10 mm beads of sealant between all connections of boards and install with tightly butted seams. Excess sealant must be spread flat with a putty knife. All seams and fastener heads in the assembly are covered with a secondary 10 mm bead of sealant and spread flat. The seams should be covered 25 mm on either side of seam. All fastener/washers are covered with sealant stretching 25 mm over the washer edges.

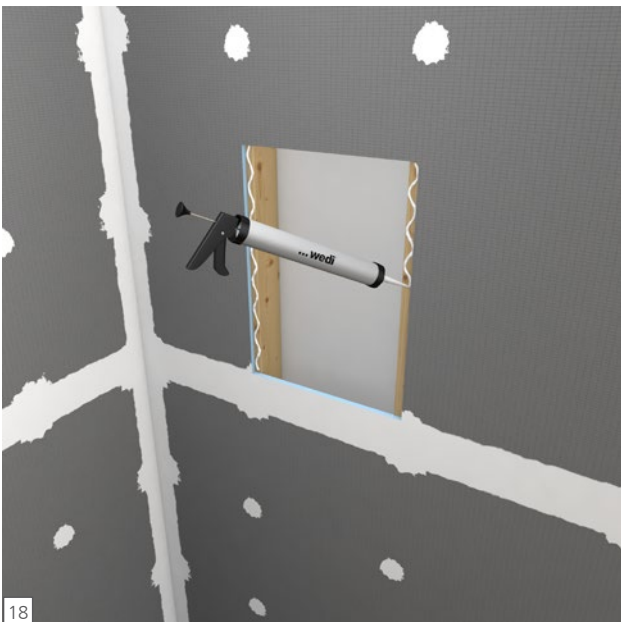

wedi Niches are installed in a cut out in the wedi wall and attached with it's flange right into the center of 450 mm studs. wedi 610 adhesive sealant is set along the connection of wall to niche.

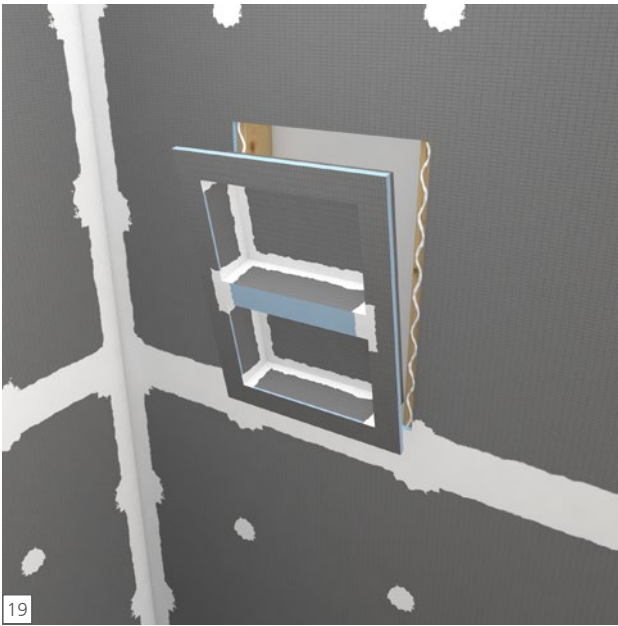

2 Fasteners each side of the niche are set to create a flush transition to the wall boards. Another 10 mm bead of wedi 610 adhesive sealant is spread over fasteners and seams.



A continuous 10 mm bead of sealant is set into the channel and along the vertical hob notch part. A circle of 10 mm sealant bead is set against the wall boards where the hob attaches. There are various different ways to waterproof the bathroom floor with wedi. The most common way is to use one of our boards in the thickness from 4mm to 50mm. Here apply the tile adhesive to the Substrate. Then apply a continuous 10mm bead of sealant into the channel of the Shower base including on the channel of the wedi board used for the bathroom floor that connect to the wedi Shower Base.



Immediately spread flat all excess sealant with a putty knife. All seams and fastener heads are covered with a secondary 10 mm bead of sealant and spread flat. The seams should be covered 25 mm on either side of seam. All fastener/washers are covered with sealant stretching 25 mm over the washer

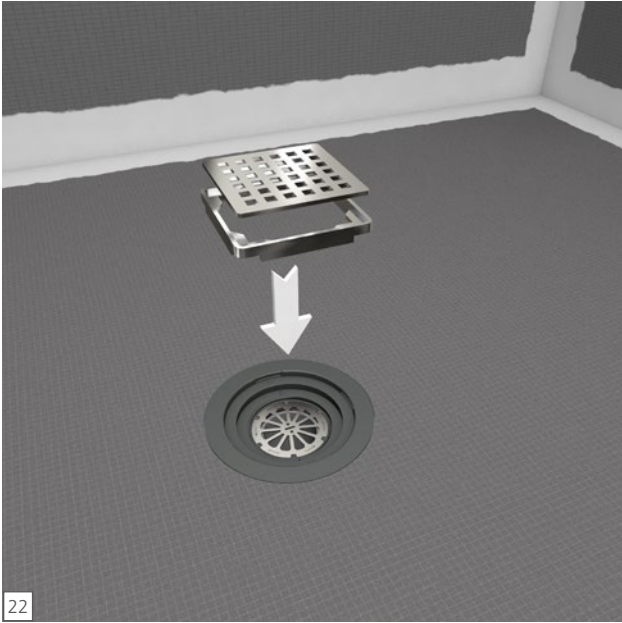

You can now insert the drain cover unit consisting of a stainless steel frame and the stainless steel cover itself. The drain cover unit fits in loosely and the drain installation is complete.



Cut the DN80 or DN100 pipe even and flush with the subfloor surface. Make sure that the cut out fits to the Fundo base's drain. Cut out a 130 mm diameter hole around the pipe's center to allow for the wedi drain to be inserted into the subfloor while the cut out area must remain free of deflection. The drain waste pipe and P-trap have to be safely affixed to and supported by the subfloor structure.



Next, install the Fundo Click and Seal drain unit. Drain components are delivered inserted inside the Drain Body. Please take the parts out and use step by step following our manual here.

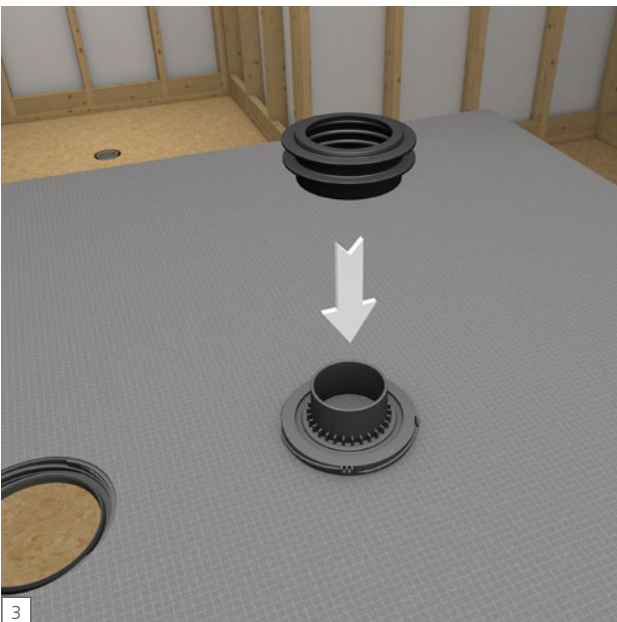

Please connect the DN80 or DN100 Adapter around drain body



Once inserted, turn the Drain Body clockwise until it “clicks” into final position and you will see the imprinted arrow on drain unit aligning at the base’s click mechanism. This will require no more than a quarter turn. Ensure a tight connection by lightly pulling and pushing on the Drain Body. The Fundo base and its Drain Unit is now ready for installation. Should you want to remove the Drain Body at any time, this can be done by pushing the snap mechanism’s plastic flap inwards using a flat headed screwdriver and while unscrewing the Drain Body to the left at the same time.

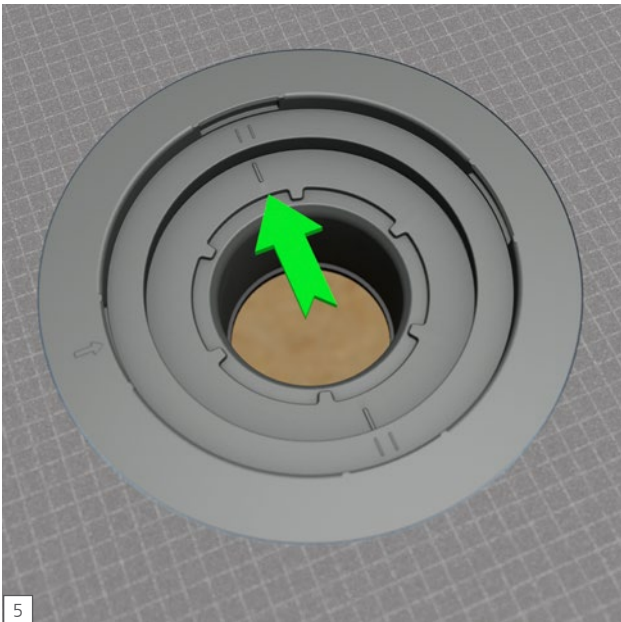

On the top side of the drain you can also verify the drain unit has successfully connected when the single hash marks are centered between the double hash marks.



Trowel the tile adhesive and comb through with a 10 × 10 mm notch trowel. Channels pointing to the entrance.



Trowel the tile adhesive on the rear side of the Fundo again using a 10 × 10 mm notch trowel. There are different ways to ensure good bond of the wedi base to the subfloor. Applying tile adhesive on both, wedi base and subfloor, is a best practice recommended to achieve full surface coverage adhesion.

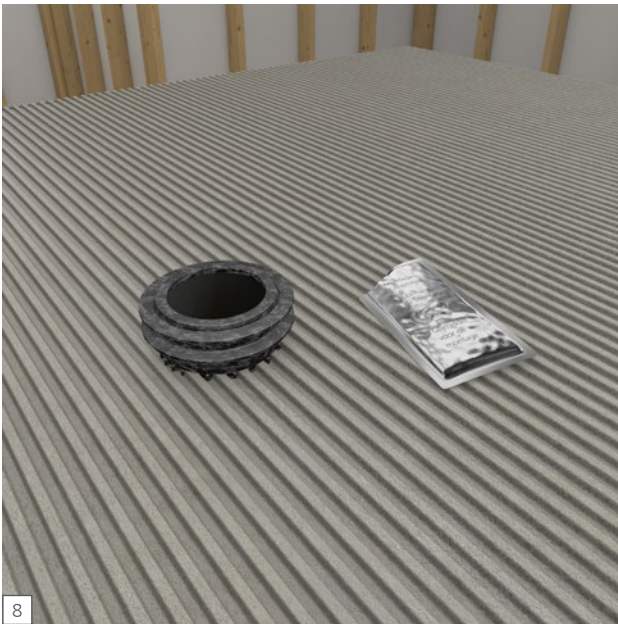

Apply the wedi provided safe Lubricant to the black rubber ring adapter

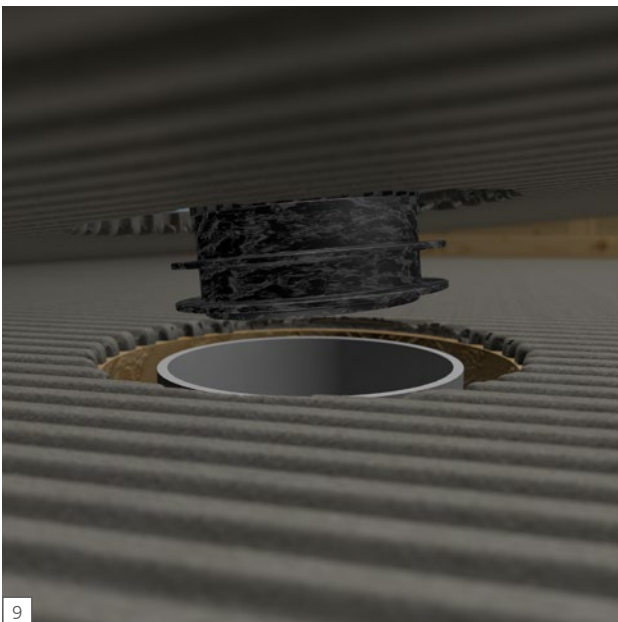

Make sure that the Adapter alligns into your pipe Settings



You can then push the Fundo Shower Base including the wedi Drain Unit into the adhesive bed firmly so that the entire Drain Body including adapter is sitting into the DN80 or DN100 Pipe



Press the Fundo firmly into the tile adhesive bed, ensuring that the installation is level and void free. Apply some weight equally and leave on surface and drain area to allow the tile adhesive to initially cure without being disturbed (e.g. tile adhesive bags). Do NOT step on the drain module to push/connect to drain body or tile adhesive. Ensure there is 100 % tile adhesive supporting the drain channel area over a completely flat subfloor

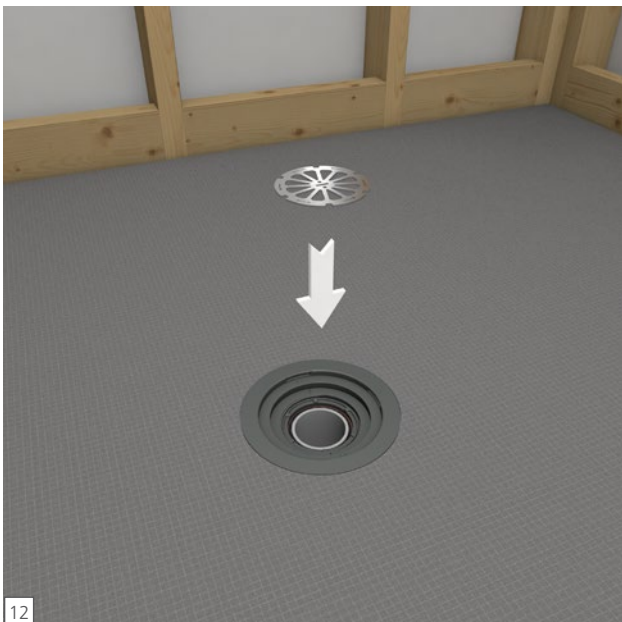

Insert Strainer Key into Locking Nut at notch connections and with Strainer Key printed side up. The Strainer Key is used as a tool to tighten the compression seal of the Drain Unit, but remains in place later to serve as a hair catcher to protect the drain and make maintenance and cleaning easy.



Set up a continuous 10 mm bead of wedi 610 adhesive sealant along the pans channel on the outer perimeter and only in areas where you can immediately install a building board into the fresh sealant.



Push the wedi board all the way into the channel of the shower base channel and its bead of sealant. Smooth out any pushed out sealant on inside seam using a putty knife. Fasten the boards directly to the studs starting 300 mm above the base and at a rate of 1 fastener per 300 mm. One extra fastener is set into the seam to the next board to create a flush transition.

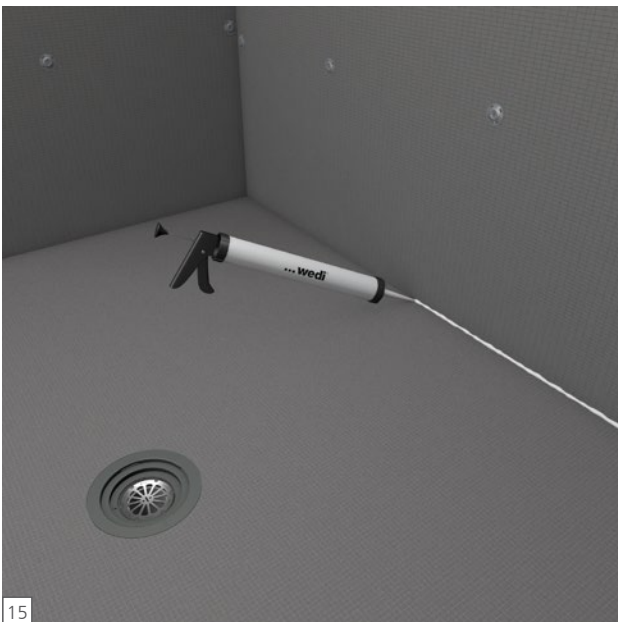

Apply continuous 10 mm beads of sealant between all connections of boards and install with tightly butted seams. Excess sealant must be spread flat with a putty knife. All seams and fastener heads in the assembly are covered with a secondary 10 mm bead of sealant and spread flat. The seams should be covered 25 mm on either side of seam. All fastener/washers are covered with sealant stretching 25 mm over the washer edges.

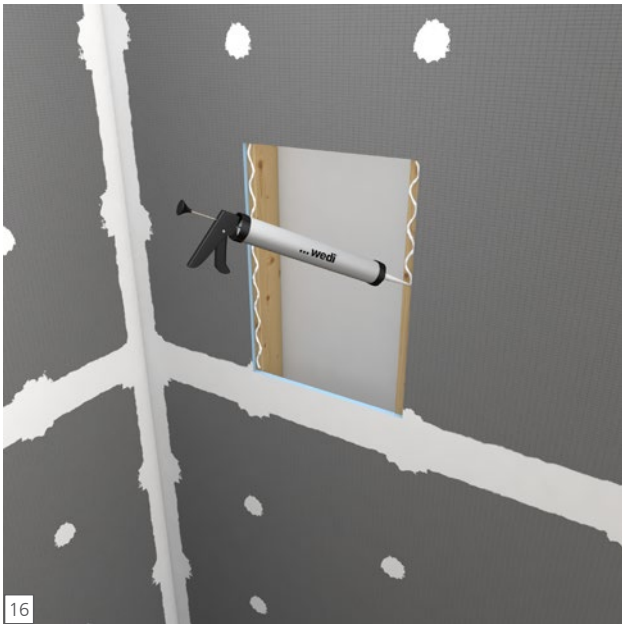

wedi Niches are installed in a cut out in the wedi wall and attached with it's flange right into the center of 450 mm studs. wedi 610 adhesive sealant is set along the connection of wall to niche.

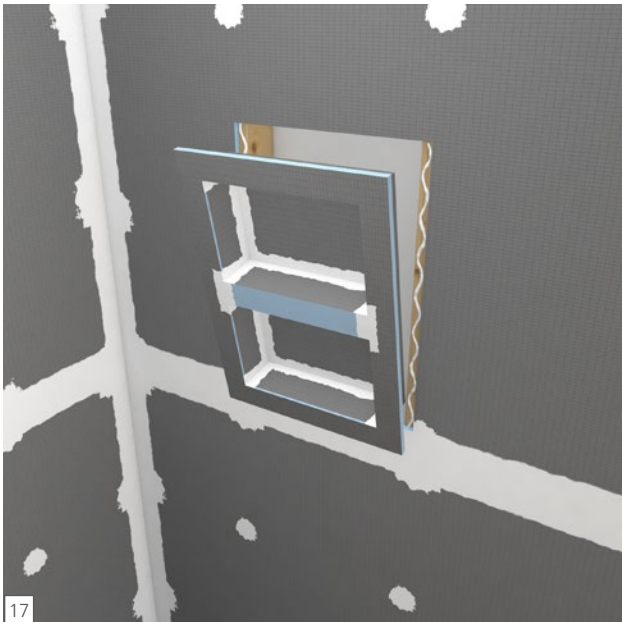

2 Fasteners each side of the niche are set to create a flush transition to the wall boards. Another 10 mm bead of wedi 610 adhesive sealant is spread over fasteners and seams.



A continuous 10 mm bead of sealant is set into the channel and along the vertical hob notch part. A circle of 10 mm sealant bead is set against the wall boards where the hob attaches. There are various different ways to waterproof the bathroom floor with wedi. The most common way is to use one of our boards in the thickness from 4mm to 50mm. Here apply the tile adhesive to the Substrate. Then apply a continious 10mm bead of sealant into the channel of the Shower base including on the channel of the wedi board used for the bathroom floor that connect to the wedi Shower Base.



Immediately spread flat all excess sealant with a putty knife. All seams and fastener heads are covered with a secondary 10 mm bead of sealant and spread flat. The seams should be covered 25 mm on either side of seam. All fastener/washers are covered with sealant stretching 25 mm over the washer

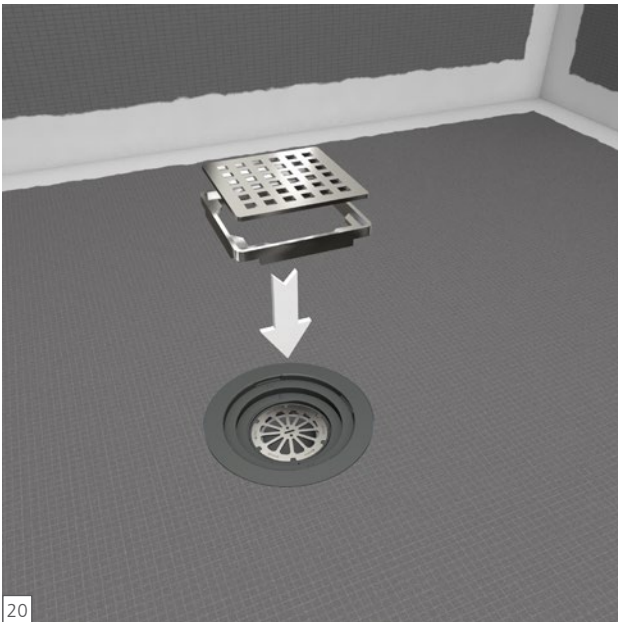

You can now insert the drain cover unit consisting of a stainless steel frame and the stainless steel cover itself. The drain cover unit fits in loosely and the drain installation is complete.



Fundo Click and Seal Height Adjustment Kit

Optionally, if you want to also increase the height of the drain cover unit, proceed as the following before finishing the drain installation. Using the Fundo Click and Seal Height Adjustment Kit as described is also recommended not only to adjust the height of the cover, but using it will close interior threaded drain surfaces so dirt cannot catch there. The drain cover extension can be cut at its lowest setting so the cover can sit flat and as low as when not using the drain cover extension.

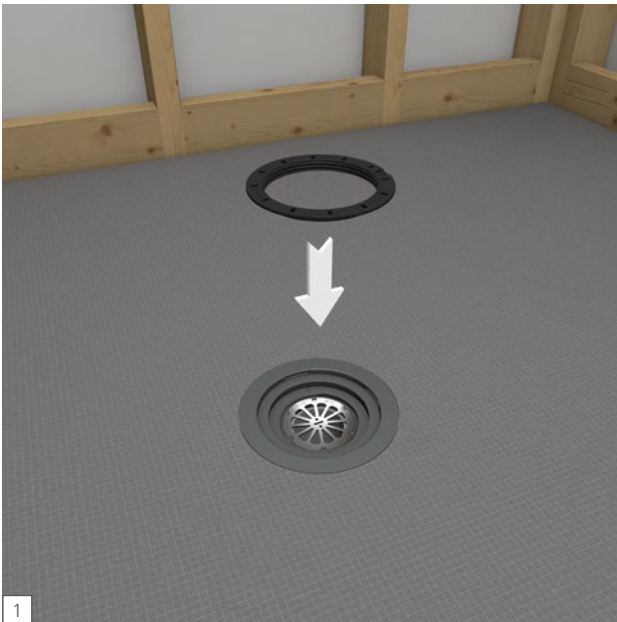

Loosely insert the Alignment Ring 1 into the Drain Unit opening with printed side up. Align the notch in Alignment Ring 1 with the arrow printed on the Drain Unit. Alignment Ring 1 has a threaded inside which will later allow you to insert a Drain Cover Extension, which will allow you to laterally and vertically move your drain cover for perfect alignment with the tile finish. Alignment Ring 1 is also needed to support the drain cover unit when no Drain Cover Extension is used. Alignment Ring 1 has built in drainage slits to allow the tile adhesive around the drain area to drain water more quickly.

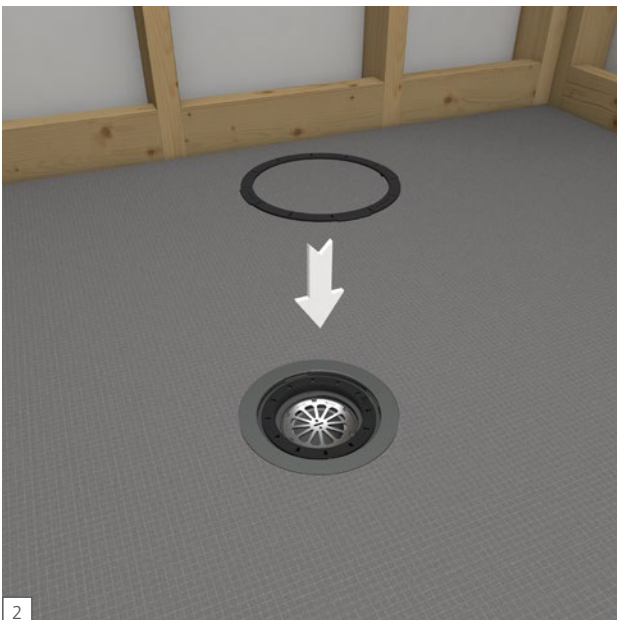

Insert the Snap Ring 2 into Drain Unit opening with printed side up. Align its arrow and protruding key fitting into the notch of the Alignment Ring 1. The Snap Ring 2 needs to be secured in place with its perimeter notches snapping into grooves which are pre-made in the Drain Unit. Snap Ring 2 is used to secure the movable Alignment Ring 1, and it is needed to later support the Drain Cover unit. It is equipped with drainage slits to allow tile adhesive around the drain area to drain water more quickly.



Optionally, use and insert the threaded Drain Cover Extension into the threaded part of the Alignment Ring 1. Dry fit the Drain Cover Extension for the needed final height position of the drain cover unit. The Drain Cover Extension only works for wedi's finished surface drain covers, but not with wedi's tileable covers due to their special water drainage design.

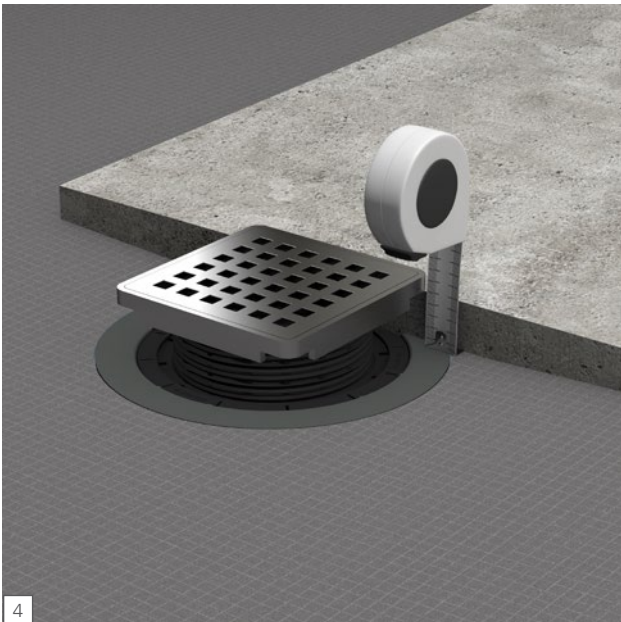

Dry-fit a tile for the shower base right next to the extended drain cover unit and determine to what height the Drain Cover Extension may need to be cut down for a drain cover top flush with the top of the tile (or drain cover top slightly below top of tile). Account for the thickness of the (compressed) tile adhesive used to install the tile.



The Drain Cover Extension can be cut to height/length at its threaded part using a fine tooth saw for a fast, clean and safe process. Make cut within one groove between threads. Please note, the threaded connection also allows for some adjustment after cuts are made. The Drain Cover Extension should connect to the threaded Alignment Ring safely and for good support, which requires at least one full turn of the extension's male threads reaching into the Alignment Ring 1's female threaded part. The extension can be used to increase the position of the drain cover by 1 ¼ in.



Place the drain cover unit loosely on the Drain Cover Extension where it fits into a tight seat. The cover is now vertically adjustable and can also move horizontally to fit the tile layout.

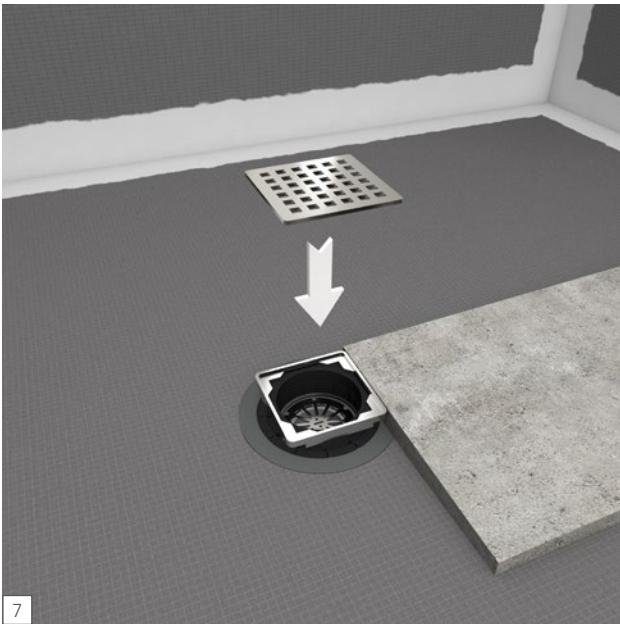

The drain cover unit can still be moved laterally 3/16 in. in either direction, and can be aligned with the tile.

wedi Fundo Primo Shower Bases | Center Drain

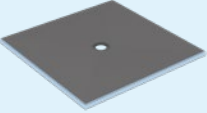
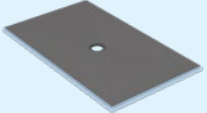
	Description	Width × Length × Thickness	Unit	Item #
	wedi Fundo Primo, square	914 × 914 × 40 mm	1 pc	073742100
	wedi Fundo Primo, rectangular	914 × 1524 × 40 mm	1 pc	073742104
	wedi Fundo Primo, rectangular	914 × 1828 × 40 mm	1 pc	073742106
	wedi Fundo Primo, square	1020 × 1020 × 40 mm	1 pc	073736250
	wedi Fundo Primo, rectangular	1219 × 1524 × 40 mm	1 pc	073742105
	wedi Fundo Primo, rectangular	1219 × 1828 × 40 mm	1 pc	073742107
	wedi Fundo Primo, rectangular	1220 × 1020 × 40 mm	1 pc	073736251
	wedi Fundo Primo, square	1220 × 1220 × 40 mm	1 pc	073736252
	wedi Fundo Primo, square	1524 × 1524 × 40 mm	1 pc	073742102
wedi Fundo Primo, rectangular	1524 × 1828 × 40 mm	1 pc	073742103	

wedi Fundo Primo Shower Bases | Offset Drain

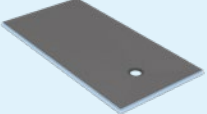
	Description	Width × Length × Thickness	Unit	Item #
wedi Fundo Primo, rectangular	1820 × 920 × 50 mm	1 pc	073736253	

Fundo Click and Seal Drain Kit DN50

	Description	Unit	Item #
Fundo Click and Seal Drain Kit DN50	1 pc	077000052	

Fundo Click and Seal Drain Kit DN80

	Description	Unit	Item #
Fundo Click and Seal Drain Kit DN80	1 pc	077000053	

Fundo Click and Seal Drain Kit DN100

	Description	Unit	Item #
	Fundo Click and Seal Drain Kit DN100	1 pc	077000057

Fundo Click and Seal Height Adjustment Kit

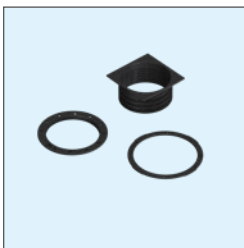
	Description	Unit	Item #
	Fundo Click and Seal Height Adjustment Kit	1 pc	077000054

wedi Fundo Drain Cover Set Tileable

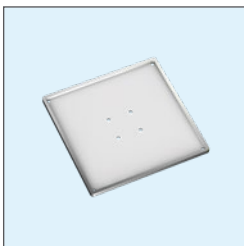
	Description	Unit	Item #
	wedi Fundo Drain Cover Set Tileable for tiles height of maximum 13 mm	1 pc	US1000061

wedi Fundo Drain Cover

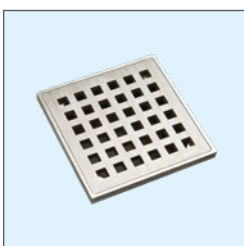
	Description	Width × Length × Thickness	Unit	Item #
	wedi Fundo Drain Cover Set, Brushed Stainless Steel	100 × 100 mm	1 pc	US1000059

wedi 321 Superbond lite

	Description	Contents	Item #
	wedi 321 Superbond lite, adhesive	10 kg	110025321



Did you know?

Great quality installation results depend on not only having great products to use – the Know-How and Experience in how to use them is key too. We have trained a variety of installers around the country and now they fully know and appreciate what they can achieve with wedi.

This educational service is offered to all professional contractors of all trades and wedi's local Technical Sales Support Managers come out on site and install with you when you do your first wedi shower installation. Your peace of mind – at no charge. Just a call away!

wedi has been the first and only XPS foam shower system that achieved the CodeMark certification in Australia and New Zealand, which guarantees you a non-contestable compliance and mandatory approval.

The CodeMark provides mandatory acceptance by building control authorities, which other forms of evidence, such as product opinion and appraisals do not have. It shows a clear demonstration that the wedi products, as a full system, meets the mandatory compliance requirements of Australia and New Zealand.

wedi-quality and performance certified by:



Be sure to ask for:



wedi Australia & New Zealand

Phone: +61 437 678 459

info@wedi.com.au
www.wedi.com.au

Your local wedi distributor:

